

## BE 1-A240/120-G5-K-BS

### Barlight

- Very compact design
- Homogenous luminous field
- Cable outlet at the front or back side usable
- Universal mounting possibility
- Metal casing
- Homogenous illumination
- High efficiency
- Robust metal casing

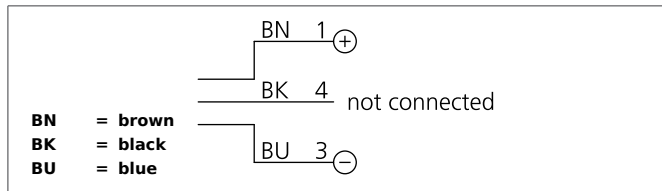

#### Safety instructions

The Instruments are not to be used for safety applications, in particular applications in which safety of persons depends on proper operation of the instruments.

These instruments shall exclusively be used by qualified personnel.

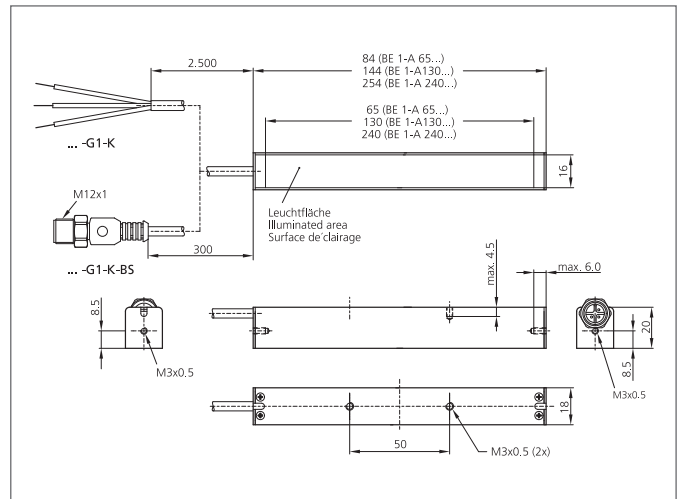

TECHNICAL INFORMATION (typ.)	+20°C, 24V DC
Design	Barlight
Illuminated area	240 mm
Light colour	White, 5600 K
Emission angle	120°
Illumination intensity	5.100 Lux (0,1 m), 1.900 Lux (0,2 m), 420 Lux (0,5 m)
Service voltage	24 V DC (Supply Class 2)
Internal power consumption	260 mA, (24 V DC)
Power	6,2 W (24 V DC)
Display	No
Ambient temperature	0 ... +40 °C permanent operation
Protection class	IP 20
Protection degree	III, operation on protective low voltage
Risk group (DIN EN 62471)	Free group
Casing material	Aluminium anodized
Connection	cable PUR, 300 mm, M12
Connecting cable	VK ...